

# Connect

Connect

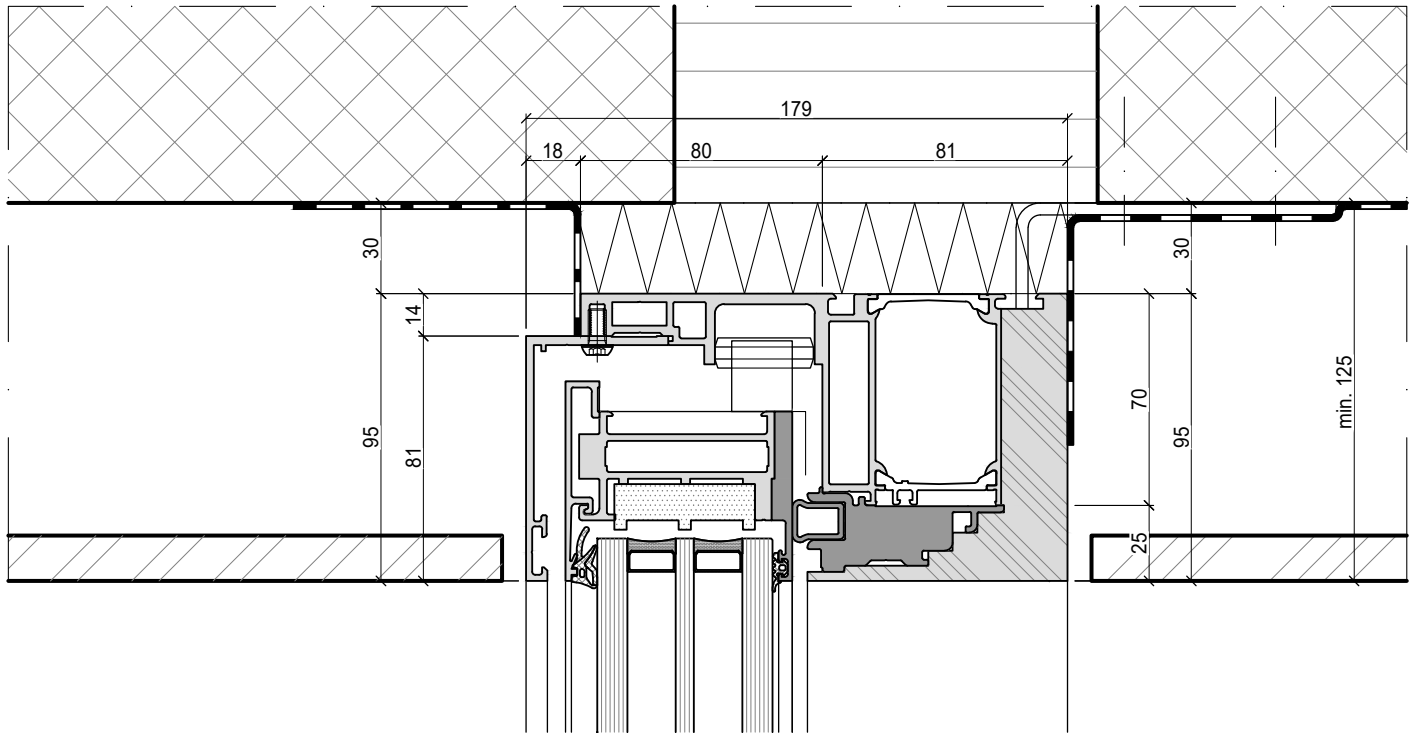

Aussen  
outside

Innen  
inside

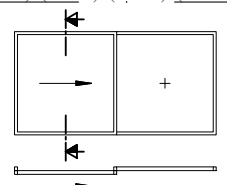
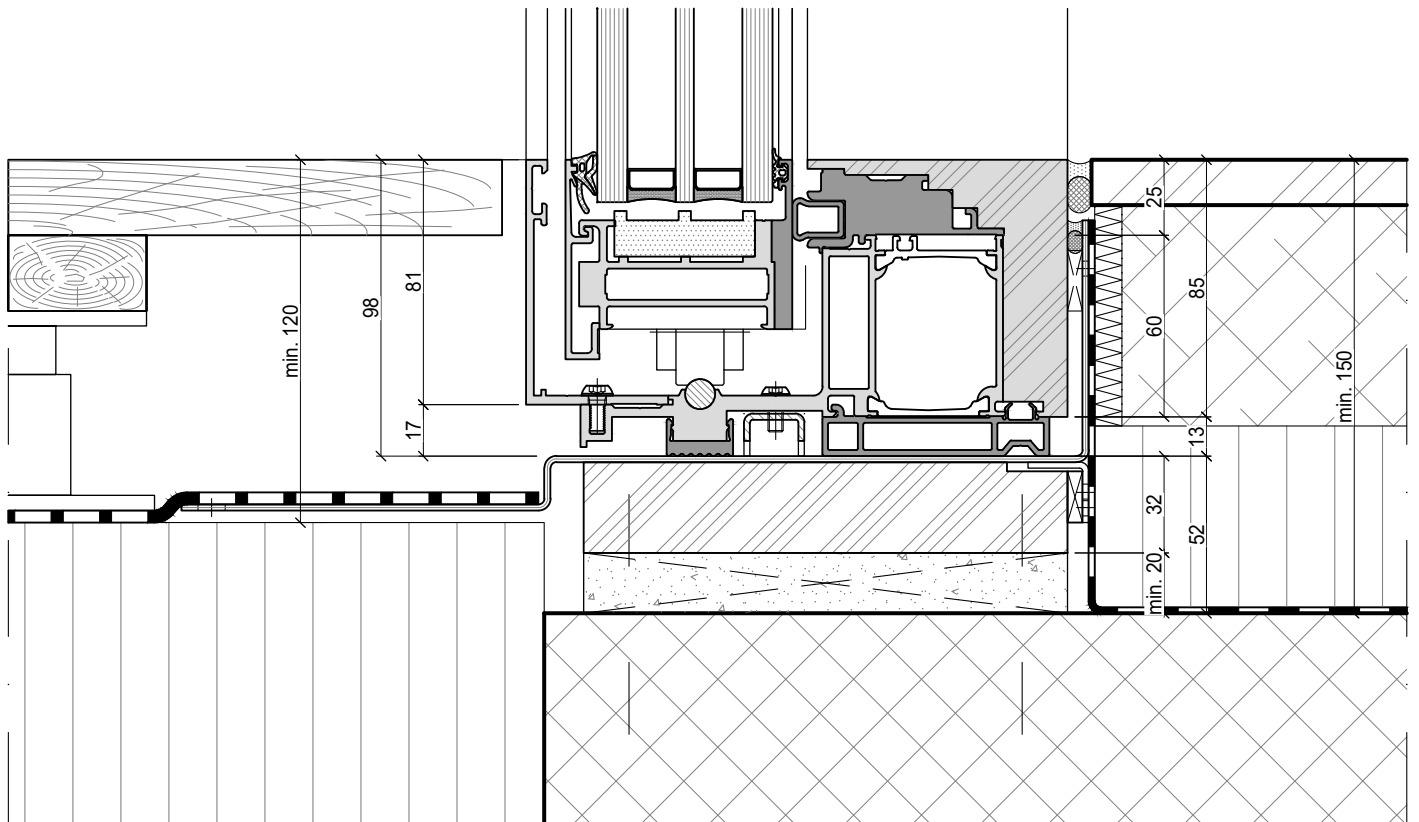

Connect

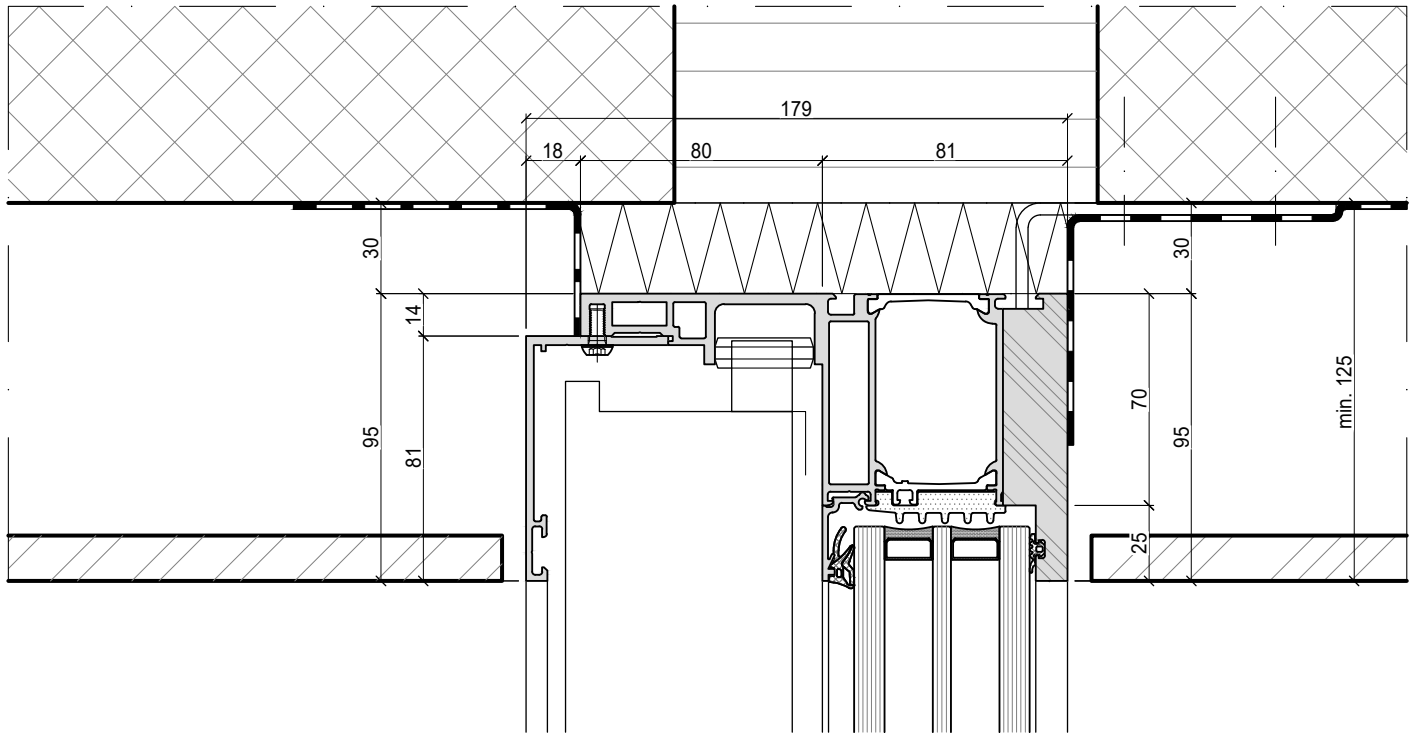

Aussen  
outside

Innen  
inside

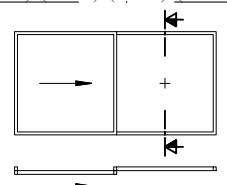
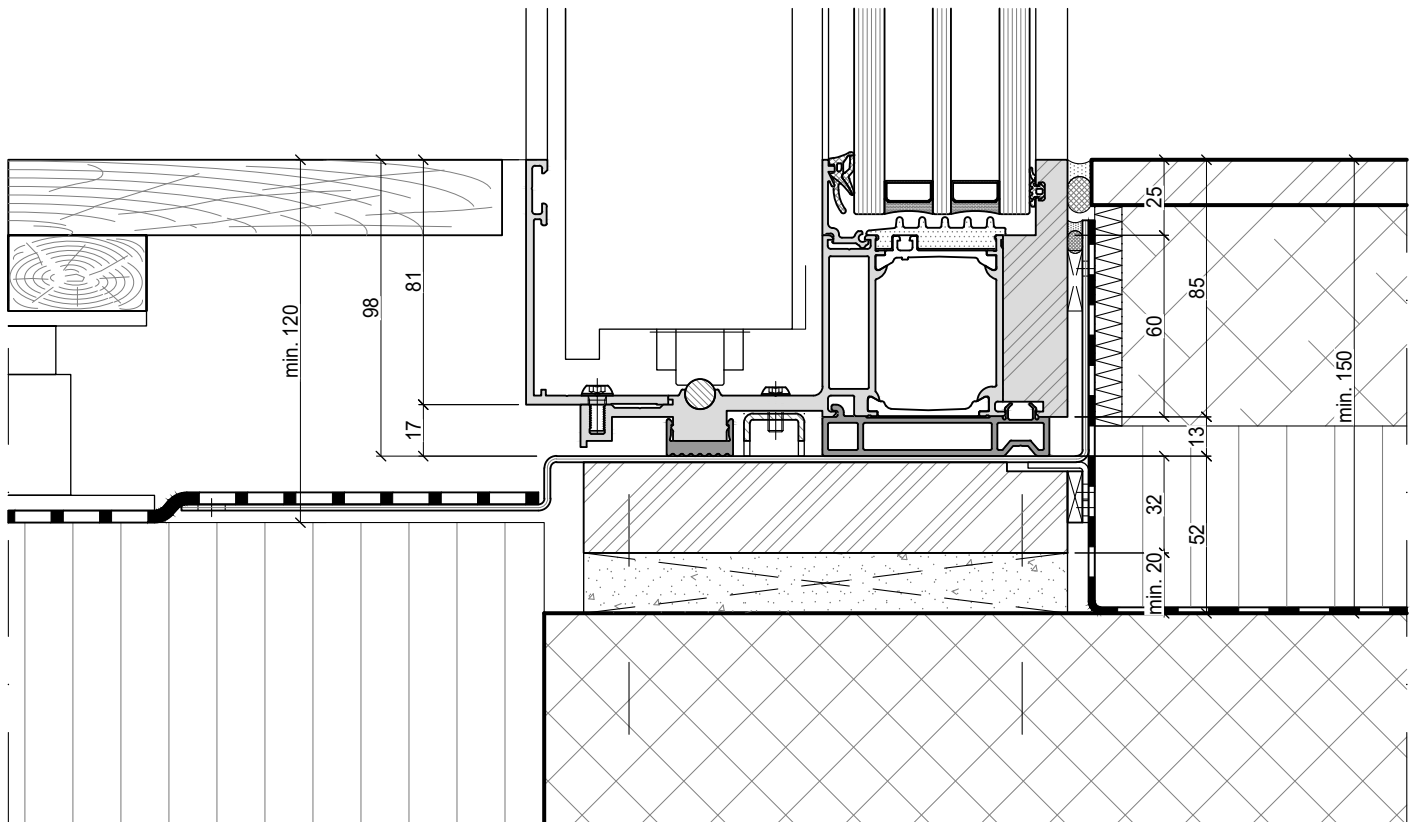

# Connect

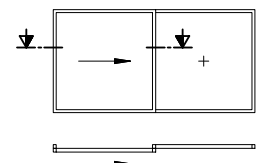
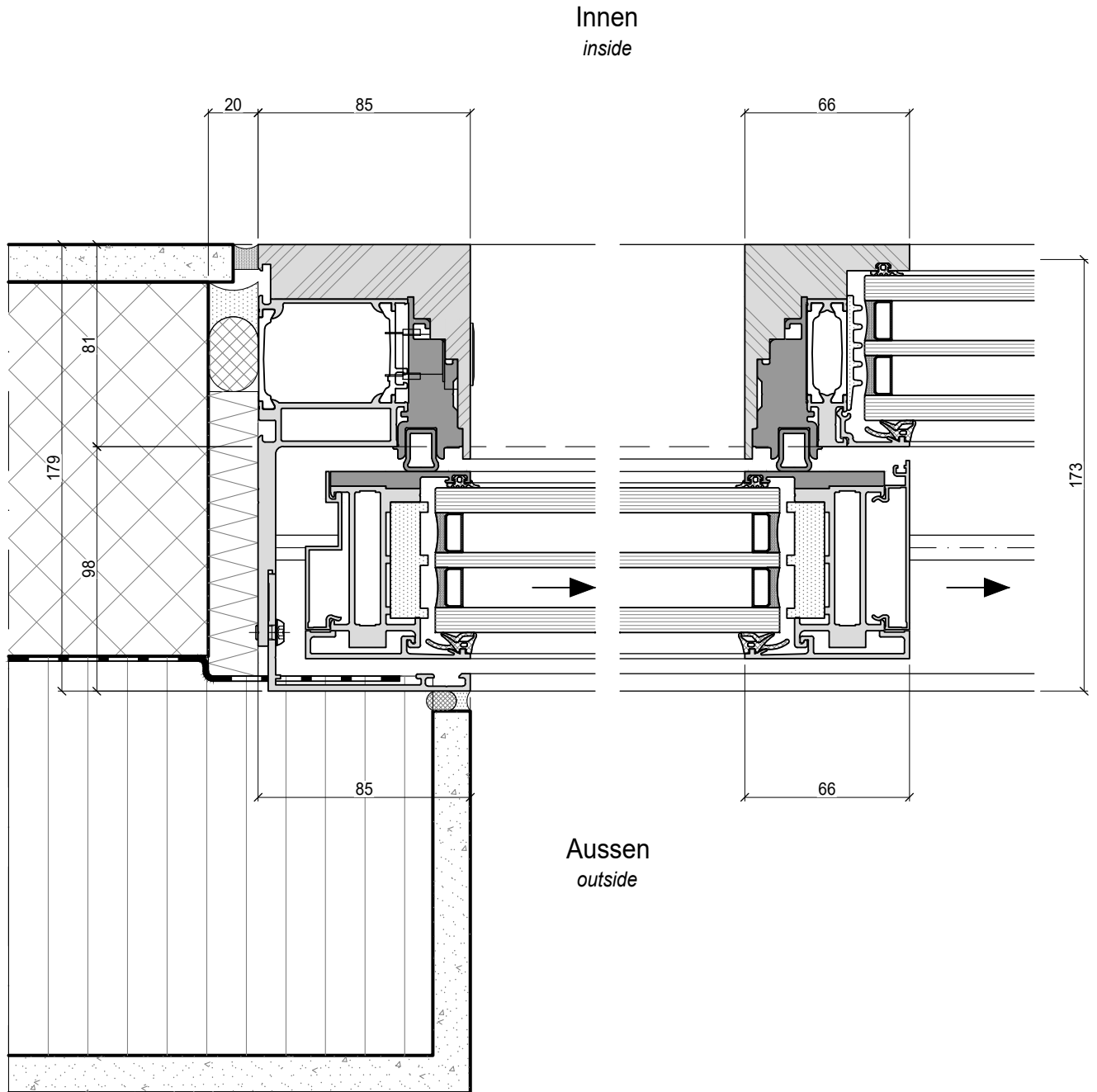

# Connect

Innen  
*inside*

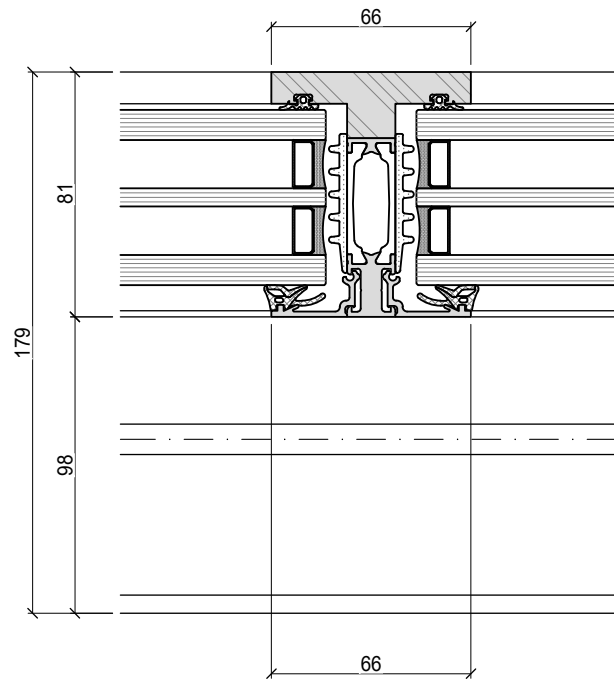

Aussen  
*outside*

